

Gru idraulica
di qualità
100% Italiana

OMV 320

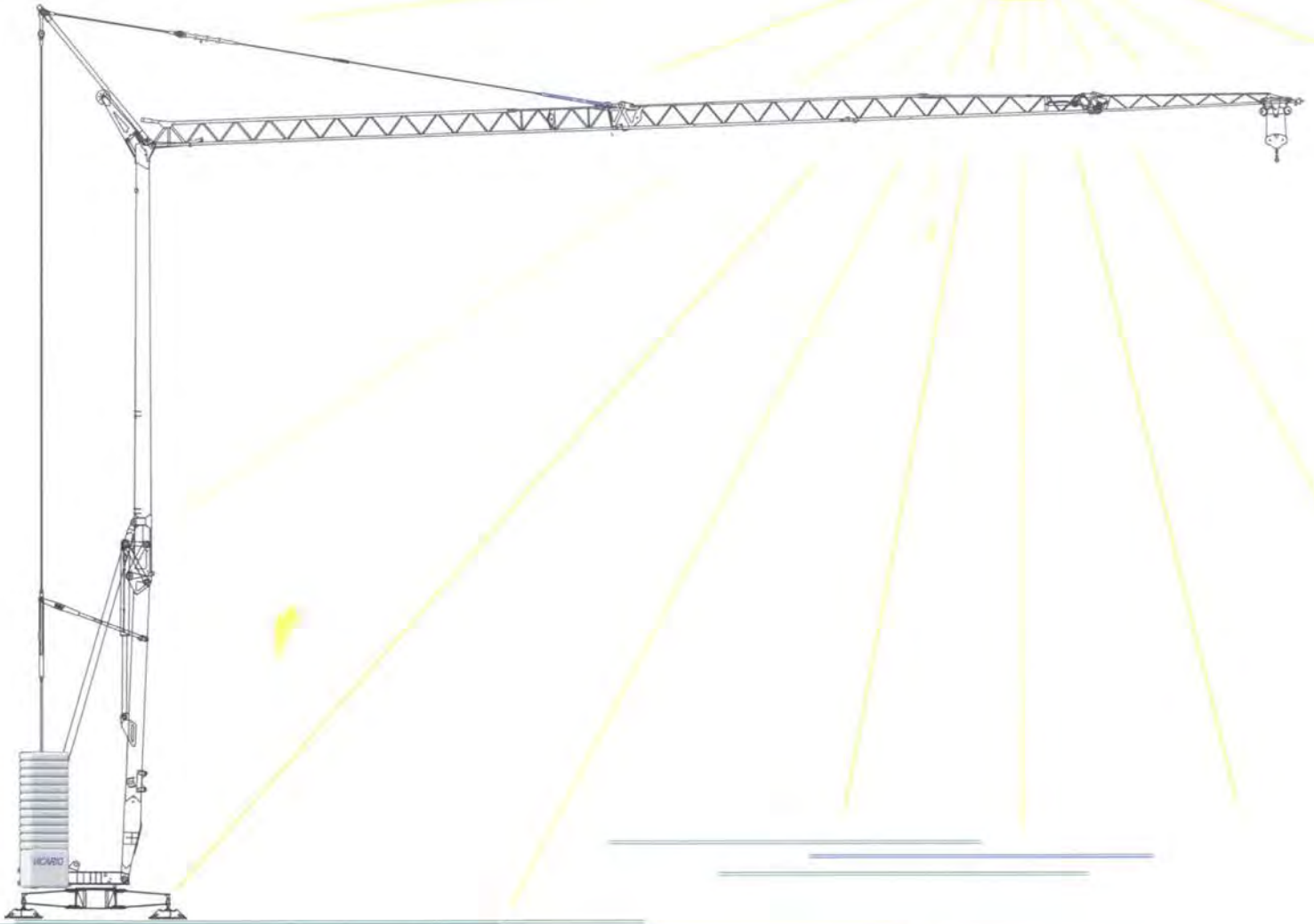

una novità delle Officine Meccaniche

Ein neuer VICARIO Kran

A new crane from VICARIO Industries

Une nouvelle grue de VICARIO

Una nueva grua de VICARIO

VICARIO

OMV 320

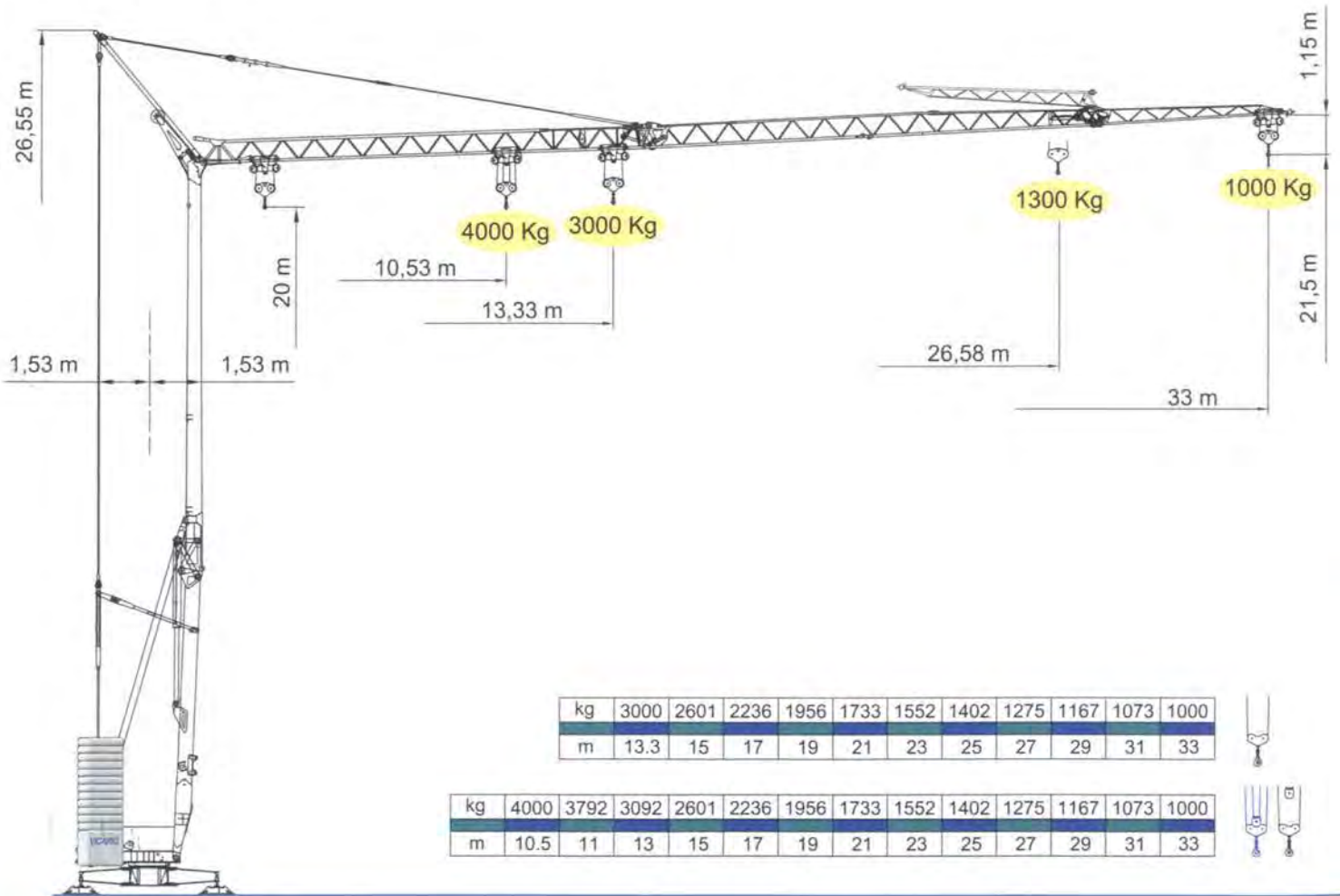
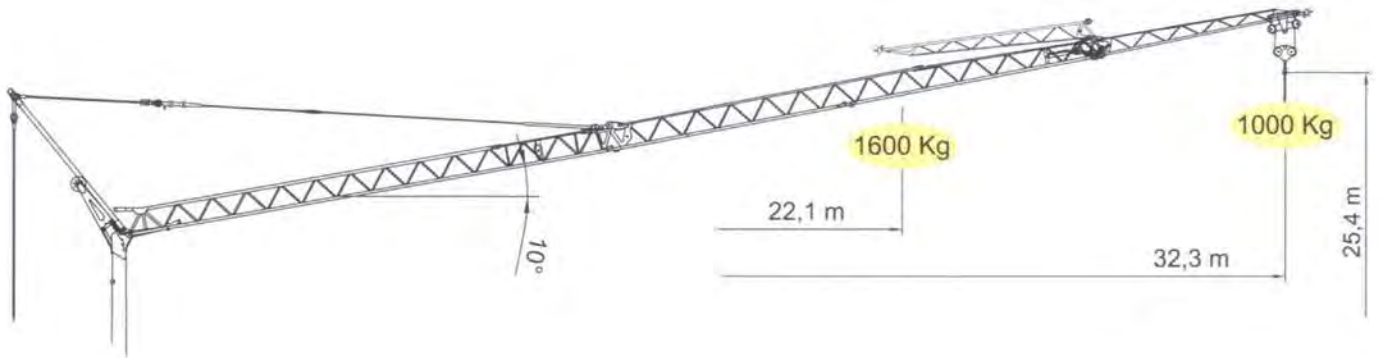
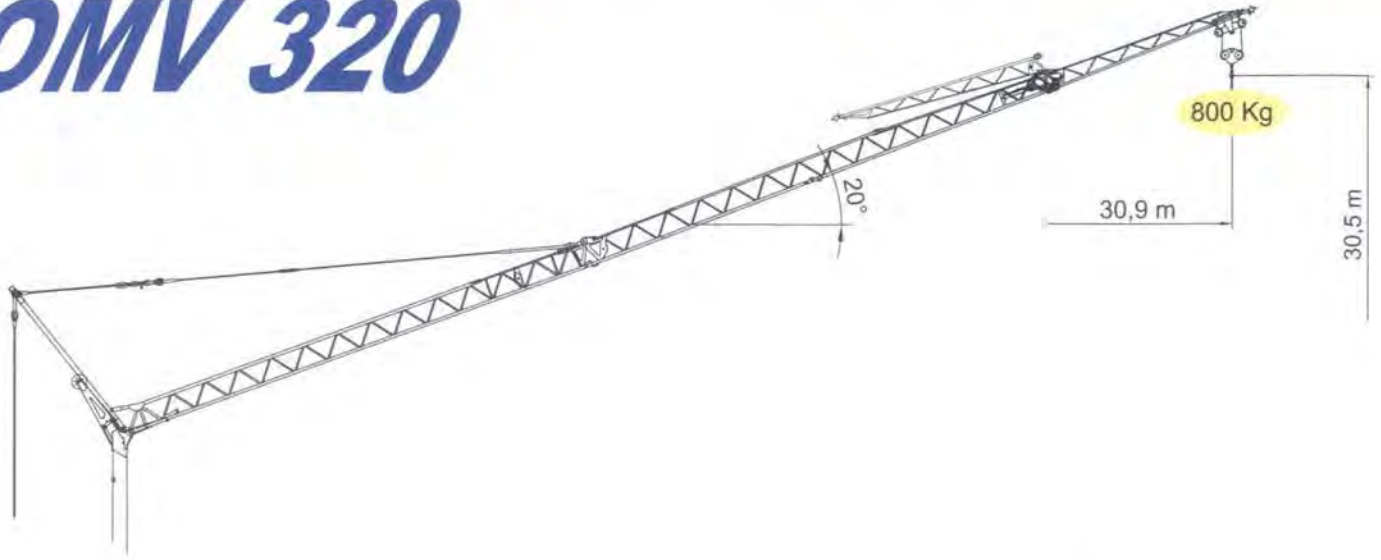

kg	3000	2601	2236	1956	1733	1552	1402	1275	1167	1073	1000
m	13.3	15	17	19	21	23	25	27	29	31	33

kg	4000	3792	3092	2601	2236	1956	1733	1552	1402	1275	1167	1073	1000
m	10.5	11	13	15	17	19	21	23	25	27	29	31	33



DOTAZIONE DI SERIE

Sollevamento "overdrive" a quattro velocità con inverter, rotazione e carrello a tre velocità con inverter, zincatura della struttura e dei tiranti, contrappeso, braccio impennabile, carrello rampante con motore e finecorsa alla base della torre, funzionamento con braccio ripiegato, comando a pulsantiera via cavo, carter di protezione per ralla e meccanismi, predisposizione per autozavorramento e radiocomando, armadio elettrico in acciaio inox, documentazione a norme CEE.

STANDARD FEATURES

4-speed lifting, 3-speed rotation and trolley with inverter control, galvanised structure, counterweight, pull-up jib, translation trolley with motor and limit switch at base of gantry, operation with folded jib, cable-operated pushbutton remote control, guard for slewing ring and mechanisms, designed to allow installation of self-ballasting device and radio control, stainless steel electrical cabinet, documentation in accordance with EU standards.

EQUIPEMENT DE SERIE

Levage a quatre vitesses, chariot et rotation à trois vitesses à contrôle électronique, galvanisation de la structure et des tirants, contrepoids, flèche relevable, moteur de chariot et fin de course à la base de la tour, fonctionnement bras replié, commande par câble, carter de protection pour la couronne et les mécanismes, predisposition pour autolestage et commande radio, armoire électrique en acier inox, documentation conforme aux normes CEE.

SERIENAUSSTATTUNG

Heben mit vier Geschwindigkeiten, Laufkatze und Rotation mit drei Geschwindigkeiten, Strukturverzinkung, Gegengewicht, hochklappbarer Arm, aufsteigender Wagen mit Motor und Anschlag an der Basis des Turms. Funktionieren mit eingeklapptem Arm. Steuerung mit Druckknopftaste via Kabel, Schutzvorrichtungen für Drehverbindungen und Mechanismen, Vorbereitung für Selbstballasteinbaue und Funksteuerung, elektrischer Schrank aus rostfreiem Stahl, Dokumentation gemäß EC Vorschriften.

DOTACION DE SERIE

Levantamiento a cuatro velocidades, carro y rotación a tres velocidades con control electrónico, galvanización de la estructura, contrapeso, brazo empuñable, carro rampante con motor y fin de carrera en la base de la torre, funcionamiento con brazo replgado, faccionamiento por pulsadores via cable, carter de protección para corona de giro y mecanismos, predisposición para autocontrapeso y radiocontrol, armario eléctrico de acero inox, documentación según normas CEE.

	400 V (+10% - 10%) 50 Hz	12 kVA
---	-----------------------------	--------

	m/l'	8	20	46	56
kg		3000	3000	1200	800
kW		11 (Inverter)			

	m/l'	8-4	20-10	46-23	56-28
kg		2000-4000	2000-4000	1200-2400	800-1600
kW		11 (Inverter)			

	m/l'	17.3	28.6	53.5 (39.3)
kW		3 (Inverter)		

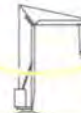
	g/l'	0,17	0,43	0,85
kW		3 (Inverter)		

	min	14
kW		3

	14280 Kg	5200 Kg + 16900 Kg
---	----------	--------------------

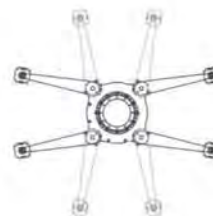
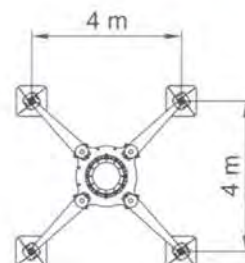
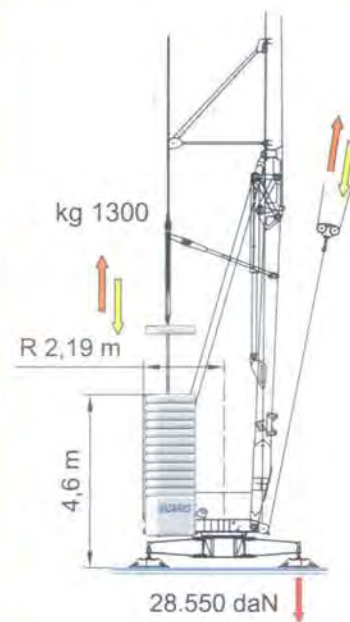
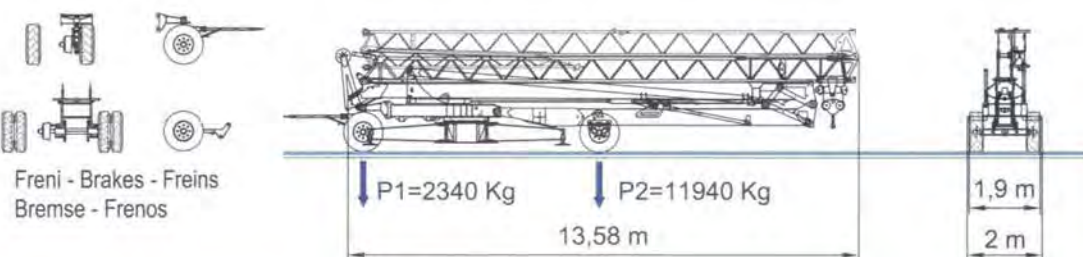
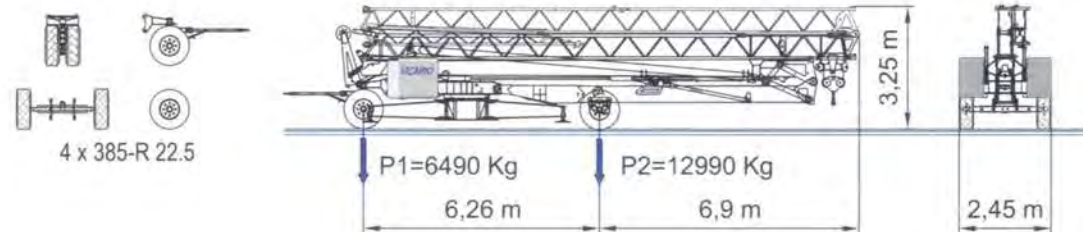

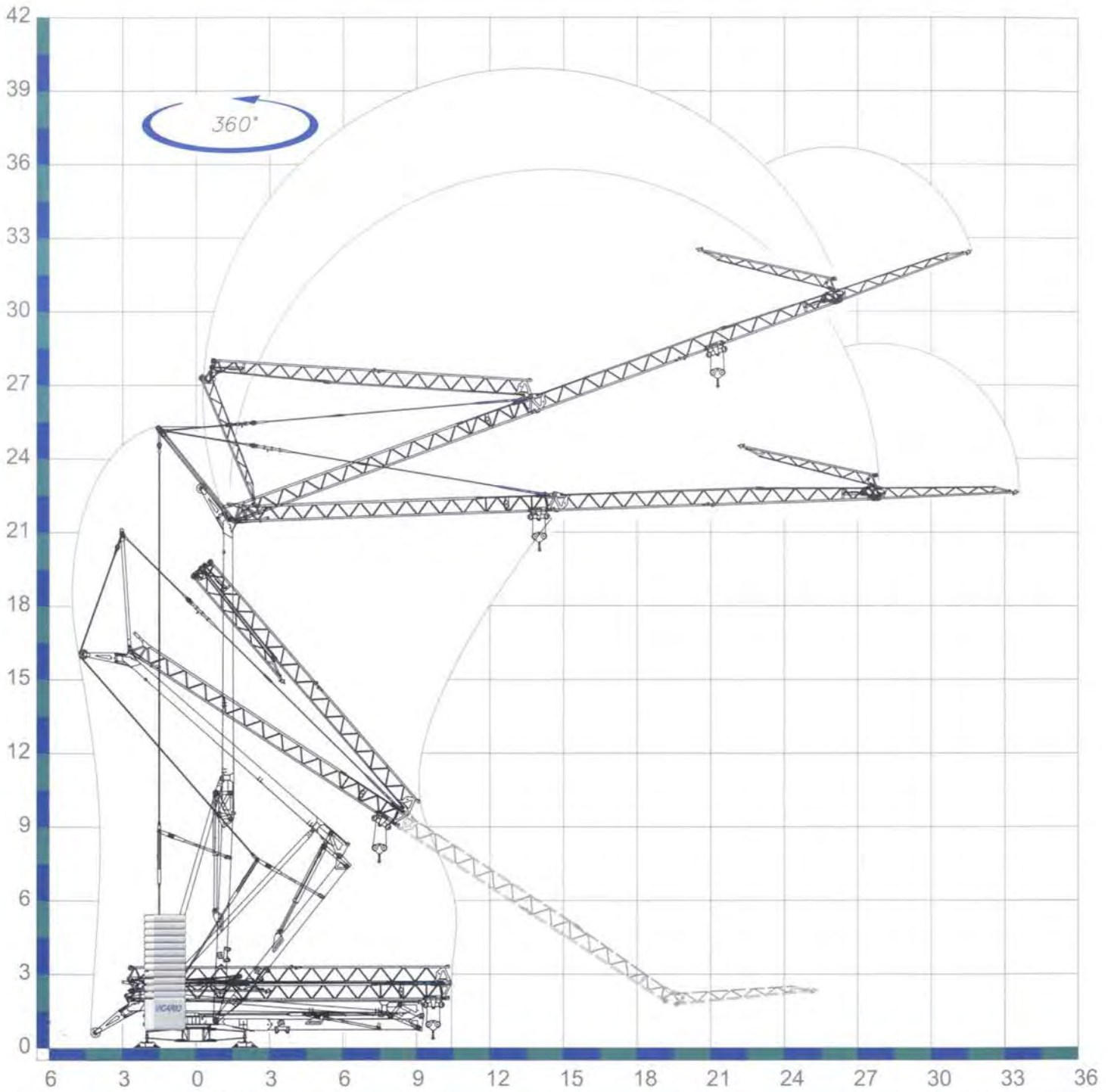

Sequenza di montaggio su 360°. Aufstellvorgang über 360°. Déroulement de montage sur 360°. Erection procedure on 360°. Montaje sobre 360°.

Ufficio Tecnico-OMV Vicario SpA - 10036

CRANES
and
TOOLS **VICARIO**
Officine Meccaniche Vicario S.p.a.

Via Piola, 4

28013 Gattico (NO) ITALIA

Tel. 0322 846690 Fax 0322 846692

Internet: www.vicariogru.com E-Mail: omv@vicariogru.com

Agente di zona: